

Data Sheet



Article number: 2304037701

Description: E+G Tubular handle
M.1043/30-300-EP

Measures

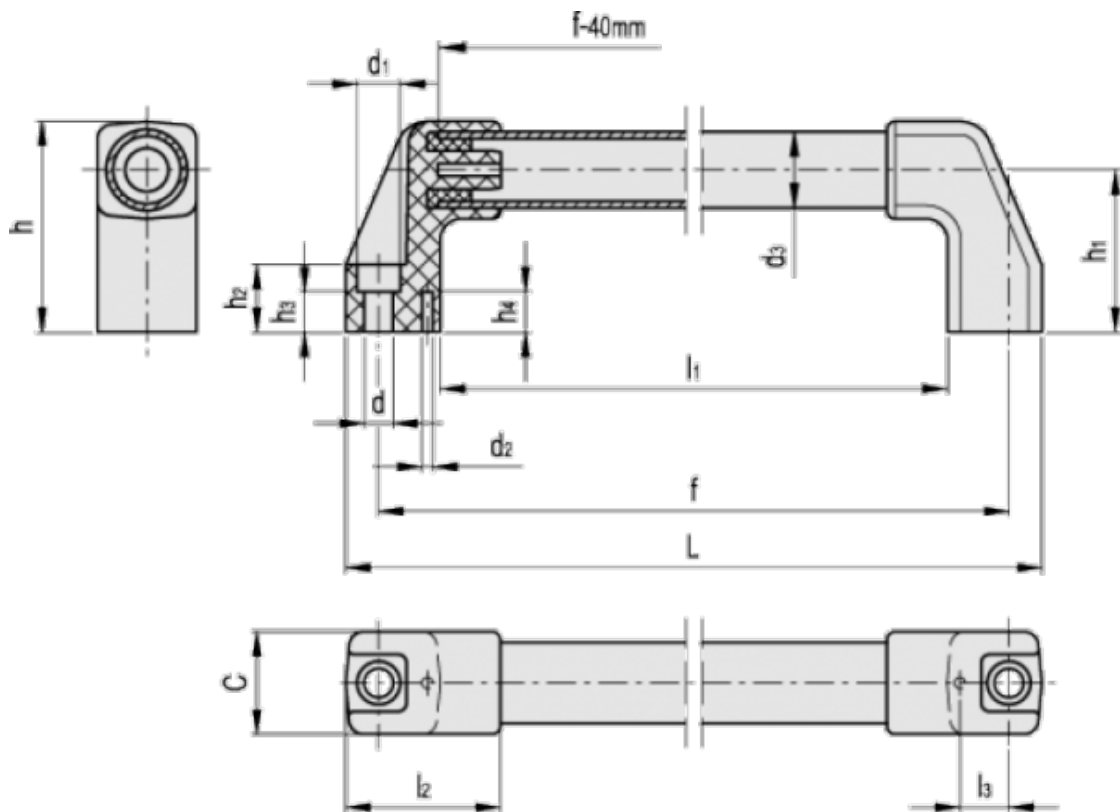

c	= 38	h1 = 60	R = load at breakage in N = 3900
d	= 10.5	h2 = 25	
d1	= 16	h3 = 15	
d2	= 4	h4 = 15	
d3	= 30	L = 324	
E = Max . working load in N = 3000		l1 = 254	
f	= 300	l2 = 57	
h	= 78	l3 = 18	